



MINISTRY OF LABOUR & SOCIAL SECURITY

"Providing Opportunity, Stability and Social Protection"



Jamaica Council for
Persons with Disabilities
EDUCATING • ADVOCATING • EMPOWERING

ACCESSIBILITY

CHECKLIST



2023 Edition

The Jamaica Council for Persons with Disabilities

ACCESSIBILITY CHECKLIST

The Jamaica Council for Persons with Disabilities (JCPD) having received the relevant copyright permission is pleased to provide the Accessibility Checklist, which has been adopted from The Access Board, 2001 Edition. This Checklist is designed to be a convenient source for identifying architectural, structural and communication barriers. It is a valuable tool to assist in the removal of barriers, as it can be used to survey an entire facility or specific areas and components of the facility. The Accessibility Checklist is to be used as a guide to increase awareness of architectural, structural and communication barriers which prevents full access to buildings and facilities by persons with disabilities. This Checklist is **NOT a replacement** for National Accessibility guidelines and/or the appropriate National Building Codes.

The Checklist is designed so that a YES or N/A (Not Applicable) answer indicates ACCESSIBLE and a NO answer indicates the existence of a NON-ACCESSIBLE feature in the building or facility. All dimensions provided in this Checklist are given in units of inches, unless otherwise specified.

Although the Checklist is based on the Americans with Disabilities Act Accessibility Guidelines (ADAAG); the Checklist has been adopted based on international standards for accessibility that are relevant for Jamaica as outlined in the New National Building Code of Jamaica.

Jamaica Council for Persons with Disabilities does not discriminate on the basis of race, colour, national origin, sex, age, religion or disability and provides, upon request, and as is available, reasonable arrangements including assistive aids and services necessary to afford an individual with a disability an equal opportunity to participate in all services, programmes and activities.



The Jamaica Council for Persons with Disabilities

ACCESSIBILITY CHECKLIST TABLE OF CONTENTS

SECTION	PAGE
Signage	1
Section I. Parking	2
Section II. Walks, Curbs and Ramps	5
Section III. Entrances, Corridors and Stairs	9
Section IV. Public Restrooms	13
Section V. Public Telephones and Water Fountains	17
Section VI. Meeting Rooms	19
Section VII. Restaurants	22
Section VIII. Guest Rooms	24
Section IX. Hazards and Emergency	29
Section X. Elevators and Automated Teller Machines	31
Section XI. Accessibility for the World Wide Web	34

SIGNAGE

1. Mounting Location and Height

Is adequate signage placed in standardized, appropriate locations throughout the building or facility?
(Signs can be used to designate permanent rooms and spaces, or provide direction and information)

- Yes
- No
- N/A



**International
Symbol of
Accessibility**

Does the signage use raised letters and numerals which are also accompanied by Braille characters?

- Yes
- No
- N/A

Is the signage mounted at a height of 60 inches from floor surface to the centerline of sign?

- Yes
- No
- N/A

2. Interior Signage Adjacent to Doors

Is interior signage located on the walls adjacent to the latch side of the doors?

- Yes
- No
- N/A

Is signage mounted 60 inches above the floor surface to the centerline of the sign?

- Yes
- No
- N/A

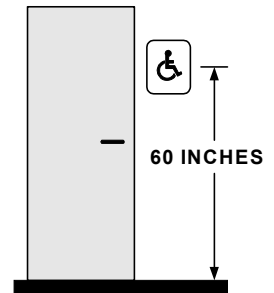

3. Exterior Signage

Is exterior signage available at non-accessible entrances and along walks that provides directions to the accessible routes and entrances?

- Yes
- No
- N/A



SECTION I: PARKING

1. Facility Parking

Does the facility have parking spaces designated for individuals with disabilities?

- Yes
- No
- N/A

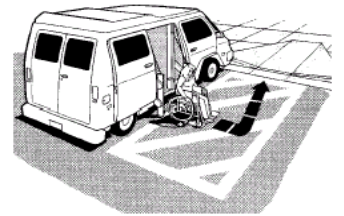

Are accessible parking spaces designated with the International Symbol of Accessibility?

- Yes
- No
- N/A

2. Entrance to Parking Lot

Are the International Symbols of Accessibility used to designate the reserved parking spaces clearly visible at the entrance to the parking area?

- Yes
- No
- N/A



3. Number of Accessible Spaces

Does the parking area have the minimum number of accessible spaces specified in the table below?

- Yes
- No
- N/A

Total Parking Spaces	Designated Accessible Parking
1 to 25	1
26 to 50	2
51 to 75	3
76 to 100	4
101 to 150	5
151 to 200	6
201 to 300	7
301 to 400	8
401 to 500	9
501 to 1000	2% of total
1001 and over	20 plus 1 for each 100 over 1000

4. Space Location

Are the accessible parking spaces on the shortest possible accessible route to an accessible building entrance?

- Yes
- No
- N/A

Are the parking spaces located on level terrain with surface slopes that do not exceed 2% in all directions? (2% slope = 2 feet change in vertical elevation over a 100 foot horizontal distance)

- Yes
- No
- N/A

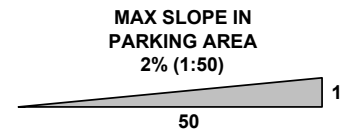

SECTION I: PARKING

5. Parking Identification and Dimensions of Spaces

Is there a sign showing the international symbol of accessibility located above grade and visible when a vehicle is parked in the designated space?

- Yes
- No
- N/A

Are parking spaces a minimum of 96 inches (8 feet) wide?

- Yes
- No
- N/A

Is there an access aisle adjacent to the parking space having a minimum width of 60 inches (5 feet)?

- Yes
- No
- N/A

Do accessible parking spaces not located adjacent to the accessible entrances have signage that indicates the direction to these entrances?

- Yes
- No
- N/A

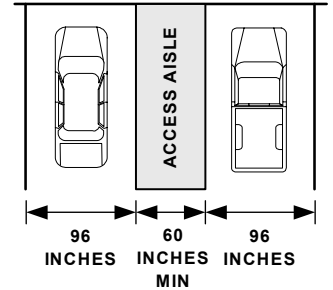

6. Van Parking Space

Do accessible parking spaces for vans have adequate vertical and horizontal clearance? (Minimum 98 inches high and minimum 16 feet wide to accommodate both parking space and access aisle)

- Yes
- No
- N/A

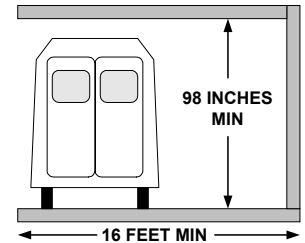

7. Van Accessibility

Is there at least one parking space designated "Van Accessible" with signage and does this space have a minimum 96 inch (8 foot) wide access aisle?

- Yes
- No
- N/A

Is there at least one van accessible space for every eight accessible parking spaces?

- Yes
- No
- N/A

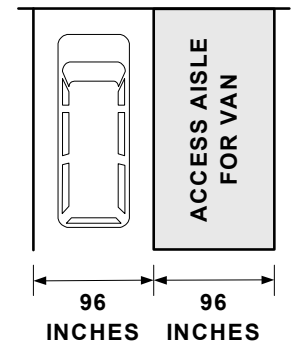

8. Passenger Loading Zone

Does the passenger loading zone have an unobstructed access aisle at least 60 inches (5 feet) wide and 20 feet long adjacent and parallel to the vehicle pull-up space?

- Yes
- No
- N/A

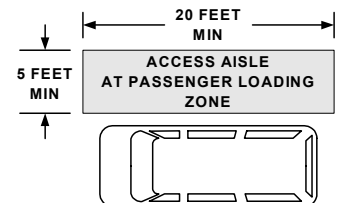

SECTION I: PARKING

9. Curb Ramp Placement

Are curb ramps provided wherever an accessible route crosses a curb?

- Yes
- No
- N/A

Do curb ramps have a maximum slope of 1:12 and minimum width of 36 inches?

- Yes
- No
- N/A

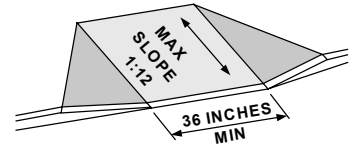

If the curb ramp crosses a pedestrian route and is not protected by handrails or guardrails, does it have flared sides with a maximum slope of 1:10?

- Yes
- No
- N/A

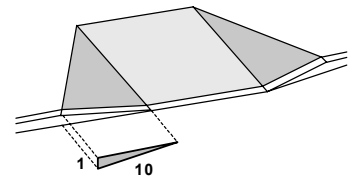

10. Medical Facilities

For facilities providing medical care or similar services for persons with mobility impairments:

- Yes
- No
- N/A

Are 10% of the total spaces reserved for persons with disabilities at outpatient facilities?

Are 20% of the total spaces reserved for persons with disabilities at facilities specializing in treatment of persons with mobility impairments?

- Yes
- No
- N/A

11. Valet Parking

If valet parking is available, is the passenger loading/unloading zone on an accessible route and does it comply with Section I, Part 8 above?

- Yes
 - No
 - N/A
-

SECTION II: WALKS, CURBS AND RAMPS

1. Ground and Floor Surfaces

Are ground, walk and floor surfaces along accessible routes stable, firm and relatively slip-resistant under all weather conditions?

- Yes
 No
 N/A

2. Changes in Surface Level

Are all ground and floor surfaces free of abrupt changes in surface level that do not exceed 1/4 inch in height?

- Yes
 No
 N/A

Where vertical elevation changes are between 1/4 and 1/2 inches in height, is the level change beveled with a slope no greater than 1:2?

- Yes
 No
 N/A

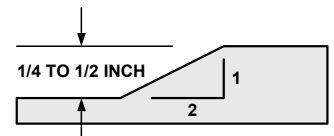

Are ramps provided for vertical elevation changes greater than 1/2 inch in height?

- Yes
 No
 N/A

3. Sidewalk Widths

Do sidewalks and ramps have a minimum clear width of 36 inches with an occasional space of 60 x 60 inches located at reasonable intervals not exceeding 200 feet which is used for turning and passing?

- Yes
 No
 N/A

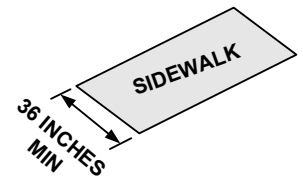

4. Gratings

Are gratings located on walking surfaces designed so that openings do not exceed 1/2 inch in one direction?

Note: If gratings have elongated openings, the openings must be placed so that the long dimension is perpendicular to the direction of travel.

- Yes
 No
 N/A

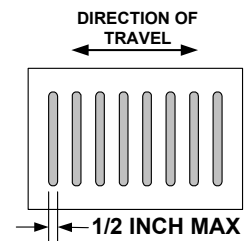

5. Width of Curb Ramps

Are curb ramps a minimum of 36 inches wide, exclusive of flared sides?

Note: Curb ramps shall not extend into traffic lanes.

- Yes
 No
 N/A

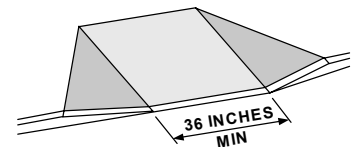

SECTION II: WALKS, CURBS AND RAMPS

6. Sides of Curb Ramps

If curb ramps cross the walking path of pedestrians, do the curb ramps have flared sides with maximum slope of 1:10 (one inch vertical rise to every 10 inches of horizontal distance)?

If curb ramps do not have flared sides, do the ramps have either a handrail or guardrail?

- Yes
- No
- N/A
- Yes
- No
- N/A

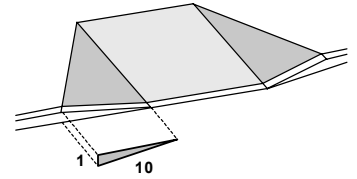

7. Ramp Slope

Is the maximum slope of all ramps 1:12 (1 inch of vertical rise to every 12 inches of horizontal distance)?

Note: Any part of an accessible route having a slope exceeding 1:20 is considered a ramp and must comply with the requirements stated in Part 7, 8, 9, 10 and 11 of this Section.

- Yes
- No
- N/A

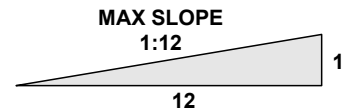

8. Landings

Do ramps and curb ramps have a 60 inch (5 feet) long level landing at the top and bottom?

Do ramps have a 60 x 60 inch level landing at locations where ramps change direction (switchback) or at intervals of 30 inch vertical rise?

- Yes
- No
- N/A
- Yes
- No
- N/A

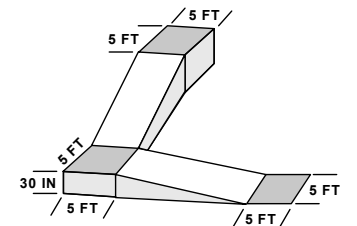

9. Sidewalk and Ramp Handrails

Do sidewalks and ramps with a vertical elevation change (rise) greater than 6 inches or horizontal run greater than 72 inches have handrails on both sides?

- Yes
- No
- N/A

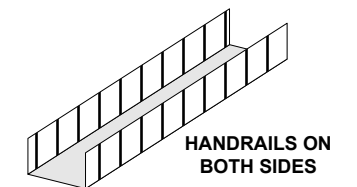

10. Handrail Location

Is the top surface of all handrails mounted between 34 inches and 38 inches above ramp surface?

If wall mounted, is the clear space between the handrail and the wall exactly 1-1/2 inches? (See figure in Section III, Part 14)

Is the diameter of the handrail 1-1/4 inches to 1-1/2 inches or does the shape provide an equivalent gripping surface?

- Yes
- No
- N/A
- Yes
- No
- N/A
- Yes
- No
- N/A

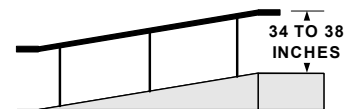

SECTION II: WALKS, CURBS AND RAMPS

11. Protective Edges on Ramps

Do ramps and landings with drop-offs have a curb which is a minimum of two inches high on all exposed sides of the ramp or landing?

- Yes
- No
- N/A

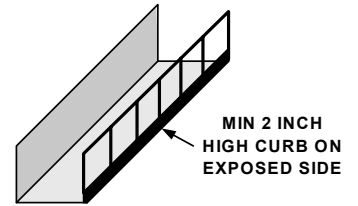

12. Temporary Ramps

Do temporary ramps meet standard ramp requirements? (See items 7, 8, 9, 10 and 11 in this Section of the Checklist)

- Yes
- No
- N/A

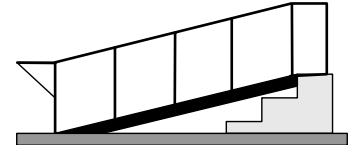

Are temporary ramps securely anchored?

- Yes
- No
- N/A

13. Ramps at Door Entrances

Do ramps at door entrances have adequate maneuvering clearances for a person using a wheelchair? (Refer to the diagrams provided on next page)

- Yes
- No
- N/A

**Refer to diagrams
on next page**

MANEUVERING CLEARANCES AT DOORS
(Taken from ADAAG 1991—Figure 25)

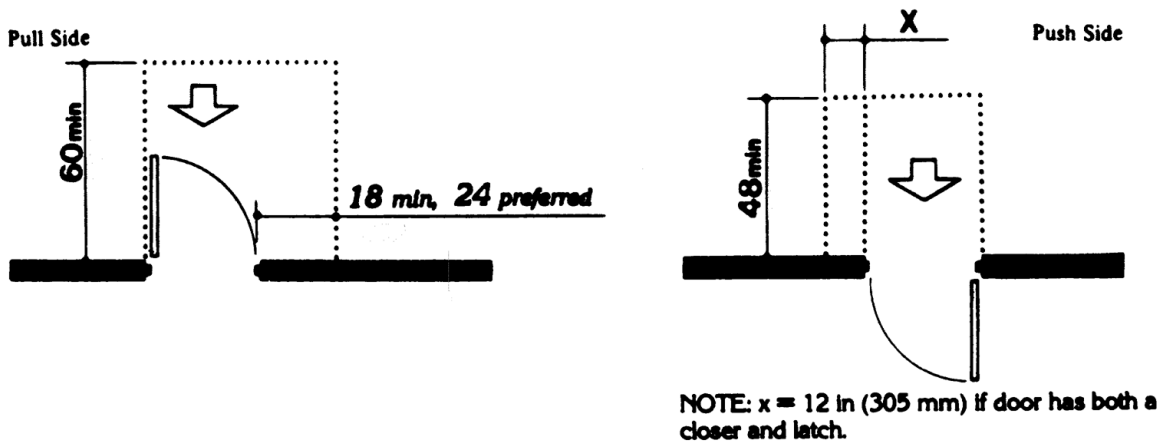

(a)
Front Approaches — Swinging Doors

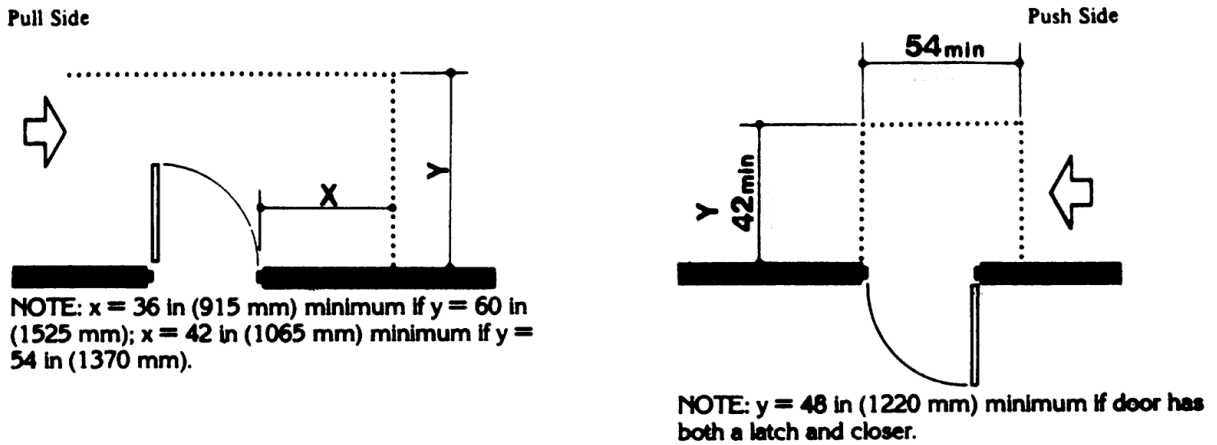

(b)
Hinge Side Approaches — Swinging Doors

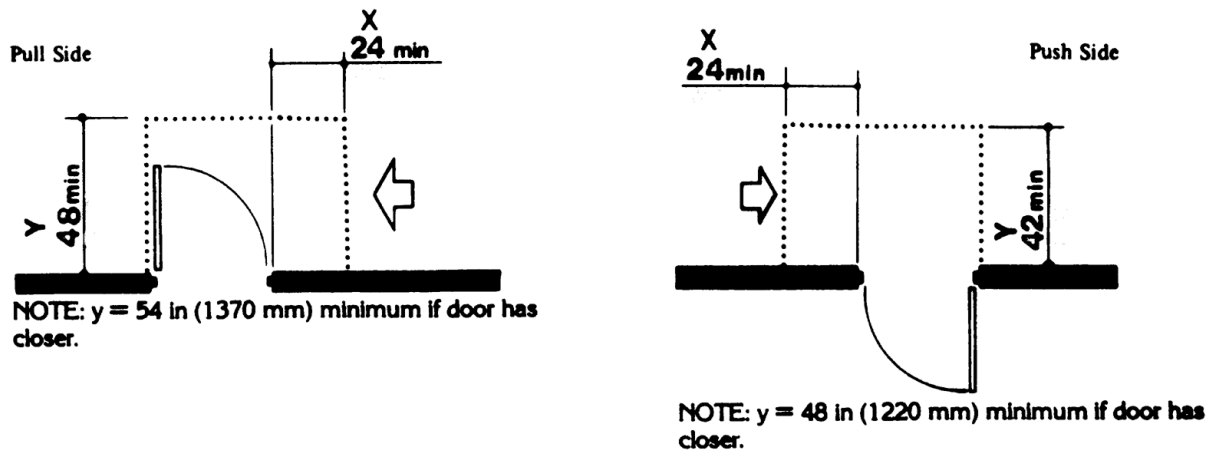

(c)
Latch Side Approaches — Swinging Doors

NOTE: All doors in alcoves shall comply with the clearances for front approaches.

SECTION III: ENTRANCES, CORRIDORS AND STAIRS

1. Marked Route

Is there at least one accessible route from the accessible parking areas or passenger loading zones to the accessible building entrance?

- Yes
- No
- N/A



If the entrance is not visible from the parking or loading areas, are the accessible routes to the entrance clearly marked with appropriate signage?

- Yes
- No
- N/A

2. Signage at Entrances

Is the International Symbol of Accessibility displayed at all accessible entrances?

- Yes
- No
- N/A



Are the primary entrances unlocked, or is provision made for a signaling device if that entrance must be locked during certain hours for security purposes?

- Yes
- No
- N/A

3. Doorway Width

Does the primary accessible entrance have a minimum clear opening (free of protrusions and obstructions) of 32 inches?

- Yes
- No
- N/A

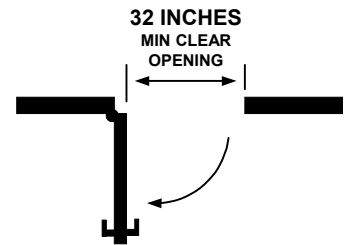

Do the push and pull side of doors have minimum maneuvering clearances conforming with the figure referred to in Section II, Part 13? (Exception: Automatic or power assisted doors)

- Yes
- No
- N/A

See diagrams referred to in Section II, Part 13

Is there a minimum of 60 x 60 inches of level space centered on the front of the accessible entrance?

- Yes
- No
- N/A

4. Door Opening Force

Can doors at accessible, exterior entrances be opened with 8.5, or less, pounds of force?

- Yes
- No
- N/A

Can interior doors be opened with 5, or less, pounds of force?

- Yes
- No
- N/A

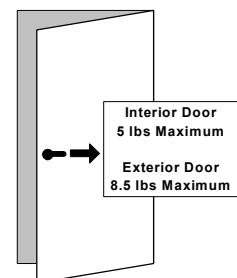

Note: Fire doors require a minimum of 15 pounds of force to open.

SECTION III: ENTRANCES, CORRIDORS AND STAIRS

5. Doormats

Are doormats stationary, flat, or recessed and less than 1/2 inch thick?

- Yes
 No
 N/A



6. Door Hardware

Are handles, pulls, latches, locks, and other operating devices on accessible doors easily grasped with one hand, and require no tight grasping, pinching, or twisting of the wrist to operate?

- Yes
 No
 N/A

Is hardware required for accessible door passage mounted no higher than 48 inches from the finished floor surface?

- Yes
 No
 N/A

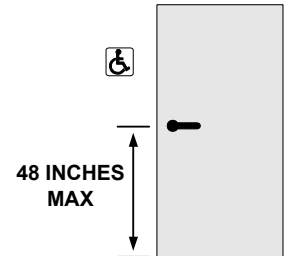

7. Doors in Series

Does approximately 48 inches, plus the width of in-swinging door(s), exist between two doors in a series to allow backing and turning space for a wheelchair or other mobility aid to clear the in-swinging door?

- Yes
 No
 N/A

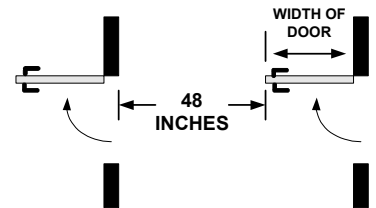

8. Automatic and Power Assisted Doors

Do automatic and power assisted doors operate in a manner and direction which do not present a hazard?

- Yes
 No
 N/A

9. Revolving Doors and Turnstiles

Is there an accessible door adjacent to all revolving doors and turnstiles?

- Yes
 No
 N/A

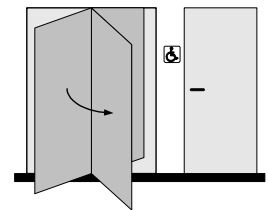

10. Threshold

Are thresholds at exterior doors flush with the floor surface?

- Yes
 No
 N/A

If thresholds are higher than 1/2 inch, are they beveled on both sides to a slope of 1:2?

- Yes
 No
 N/A

If thresholds on exterior sliding doors exceed 3/4 inches in height, are they beveled on both sides at a slope of 1:2?

- Yes
 No
 N/A

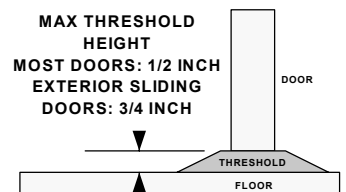

SECTION III: ENTRANCES, CORRIDORS AND STAIRS

11. Framed Glass Doors

If framed glass swinging doors are on accessible routes, is there a kick plate at least 10 inches high mounted on the bottom of the push side of the door?

Note: This feature is not required by the Kentucky Building Code or the existing ADA Accessibility Guidelines. This is a safety feature for people using wheelchairs to prevent their footrest from striking the glass.

- Yes
 No
 N/A

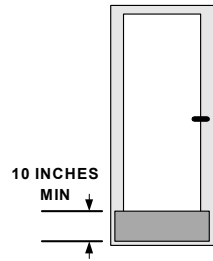

12. Stair Risers, Treads and Nosings

For all stairs and steps:

Are risers closed and have uniform height?

Note: Riser height: maximum 7 inches, minimum 4 inches.

- Yes
 No
 N/A

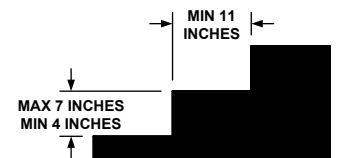

Do treads have a uniform depth of 11 inches or more?

- Yes
 No
 N/A

Do nosings project no more than 1-1/2 inches and are the undersides free of abrupt, sharp angles?

- Yes
 No
 N/A

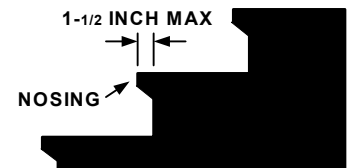

Do stair treads have non-slip surfaces?

- Yes
 No
 N/A

13. Location of Handrails

Do handrails on sides of all stairs extend at least 12 inches beyond the top riser and 12 inches plus the width of one tread beyond the bottom tread?

Is the top of the handrail mounted 34 to 38 inches above the tread?

- Yes
 No
 N/A
 Yes
 No
 N/A

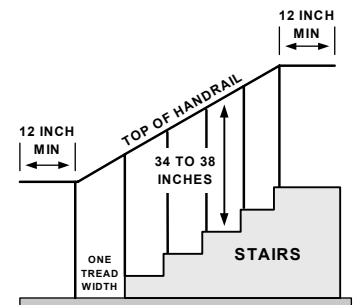

14. Handrail Dimensions

Are handrails 1-1/4 to 1-1/2 inches in diameter and easy to grasp?

- Yes
 No
 N/A

Is there a clear space of exactly 1-1/2 inches between the handrail and the wall?

- Yes
 No
 N/A

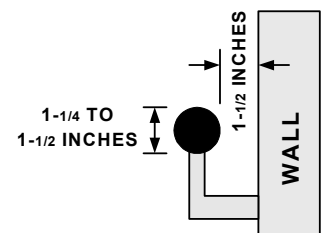

SECTION III: ENTRANCES, CORRIDORS AND STAIRS

15. Suspended Stairs

Are all suspended stairs provided with sufficient warning devices, for example, railings, planters, etc., to alert people who are visually impaired?

- Yes
- No
- N/A

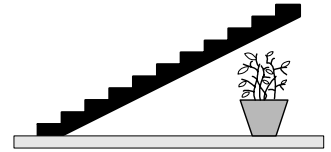

16. Protruding Objects

Do protruding and hanging objects (such as telephones, water fountains, signs, etc.) with their leading edge 27 inches to 80 inches above the floor, protrude no more than 4 inches into the path of travel?

Do walks, halls, corridors, passageways, aisles or other circulation spaces have a minimum head clearance of 80 inches?

- Yes
- No
- N/A
- Yes
- No
- N/A

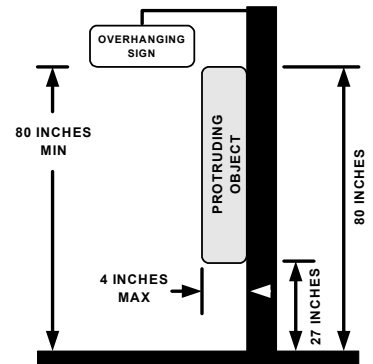

SECTION IV: PUBLIC RESTROOMS

1. Restroom Identification

Is there an accessible restroom for each gender clearly marked with an International Symbol of Accessibility mounted on the latch side of the door at 60 inches above the finish floor to the centerline of the sign?

- Yes
- No
- N/A

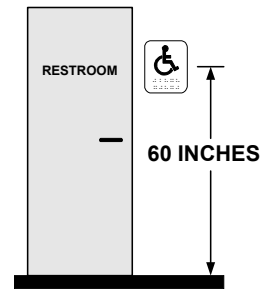

- Yes
- No
- N/A

2. Restroom Entrance

Do restroom entrances have a clear opening (free of protrusions and obstructions) of 32 inches and maneuvering clearance adjacent to the push and pull side of doors conforming to Section II, Part 13?

- Yes
- No
- N/A

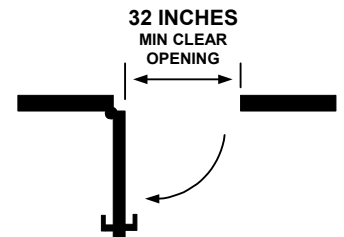

3. Restroom Mirror

Is the mirror mounted at a maximum height of 40 inches measured from the floor to the bottom edge of the reflective surface?

- Yes
- No
- N/A

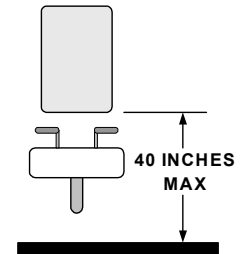

4. Lavatory Heights

Is the lavatory mounted so that the counter (rim) surface is no higher than 34 inches from the floor surface?

- Yes
- No
- N/A

Is there a clearance space of at least 29 inches provided from the bottom of apron to the floor?

- Yes
- No
- N/A

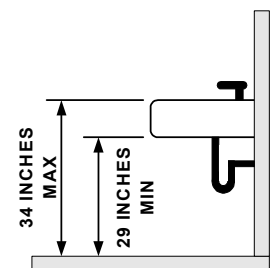

Is the drain pipe mounted so that there is at least 9 inches of clearance from the floor surface?

- Yes
- No
- N/A

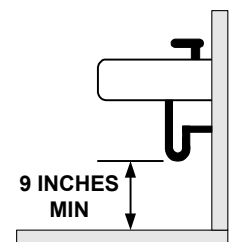

SECTION IV: PUBLIC RESTROOMS

5. Protective Pipe Covering

Is insulation or other protective covering used on hot water and drain pipes under the lavatory to prevent contact?

- Yes
 No
 N/A

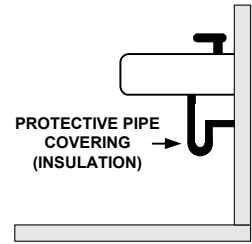

6. Lavatory Space

Is there clear floor space (30 x 48 inches) provided in front of the lavatory which includes a minimum extension of 17 inches under the lavatory to allow for forward approach?

- Yes
 No
 N/A

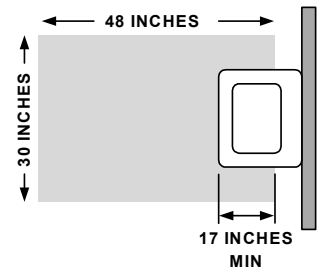

7. Faucet Controls

Are faucets controlled by a hand lever, push button, or electronic control which is easily operated by one hand, not requiring tight grasping, pinching, or twisting and requiring a maximum of 5 pounds of force or less for operation?

Note: Self-closing valves should stay open for a minimum of 10 seconds.

- Yes
 No
 N/A

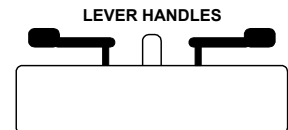

8. Dispensers in Restroom

Are restroom dispensers and accessories mounted so that there is no more than 48 inches to the highest control or operable part?

Note: Dispensers which can be reached from a parallel (side) approach may be mounted so that there is no more than 54 inches to the highest operable control or part of the dispenser.

- Yes
 No
 N/A

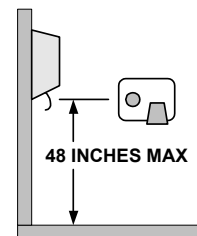

9. Stall Door

Is at least one restroom stall available having a clear opening (free of protrusions and obstructions) of 32 inches?

Does stall door swing outward?

- Yes
 No
 N/A
 Yes
 No
 N/A

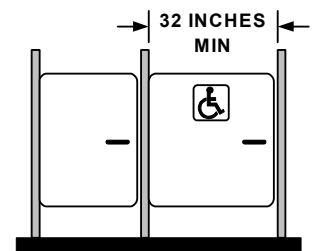

10. Standard Stall Size

Does the standard, accessible stall provide a minimum depth of 56 inches and a width of 60 inches for wall mounted water closets?

Note: Add 3 inches to the depth if the water closet is floor mounted.

- Yes
 No
 N/A

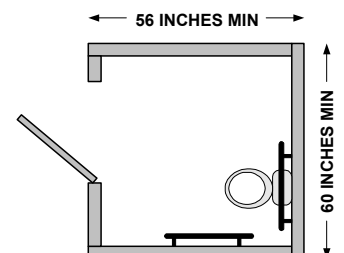

SECTION IV: PUBLIC RESTROOMS

11. Alternate Stall Size

Where a standard, accessible stall is technically infeasible, an alternate stall shall be provided. If the stall has a wall-mounted water closet, does it have a minimum depth of 66 inches?

Note: Add three inches to the stall depth if the water closet is floor mounted.

- Yes
- No
- N/A

For alternate stalls allowing a forward approach to the water closet, is there a minimum width of 36 inches and grab bars mounted on both sides of the stall?

- Yes
- No
- N/A

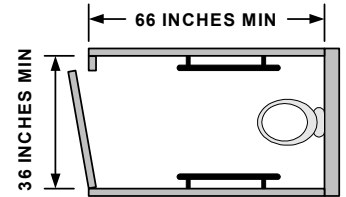

For alternate stalls allowing a side approach to the water closet, is there a minimum width of 48 inches and grab bars mounted to the side and rear of the water closet?

- Yes
- No
- N/A

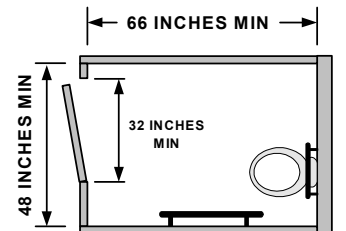

Is the center of the water closet a minimum of 18 inches from both sides of the stall?

- Yes
- No
- N/A

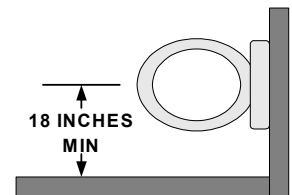

If there are six or more stalls, is one additional stall provided which is 36 inches wide with out-swinging door, grab bars on both sides, and is the seat of the water closet 17 to 19 inches from the floor?

- Yes
- No
- N/A

12. Dispensers in Commode Stall

Are toilet paper and seat cover dispensers located within easy reach of a person using the water closet?

- Yes
- No
- N/A

Do toilet paper dispensers permit delivery of a continuous flow of paper and are they mounted at a minimum height of 19 inches?

- Yes
- No
- N/A

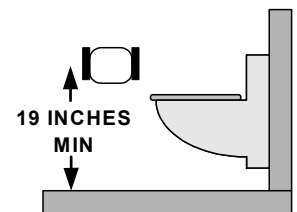

13. Urinals

Does the men's restroom have at least one stall-type or wall-hung urinal with an elongated rim which is mounted at a maximum of 17 inches above the floor?

- Yes
- No
- N/A

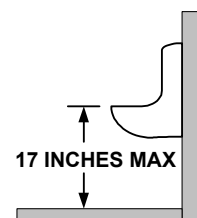

SECTION IV: PUBLIC RESTROOMS

14. Water Closet Seat

Is the top of the water closet seat 17 to 19 inches from the floor surface?

- Yes
- No
- N/A

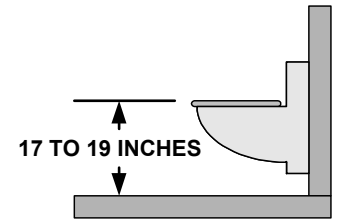

15. Grab Bars

When a side transfer in a stall is required, are two grab bars (a minimum 42 inch long bar to the side and a minimum 36 inch long bar to the back) mounted at 33 to 36 inches from the floor surface provided?

- Yes
- No
- N/A

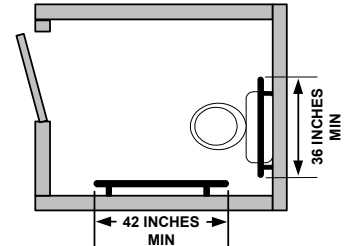

For alternate stalls (see item 11 above) are there two grab bars 42 inches in length located on both sides of the stall and mounted 33 to 36 inches from floor surface?

- Yes
- No
- N/A

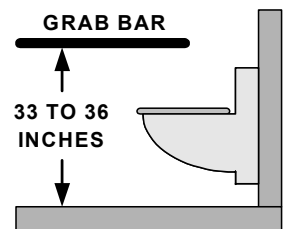

Is the diameter of each grab bar 1-1/4 to 1-1/2 inches, is the space between the wall and each grab bar 1-1/2 inches, and will each grab bar support 250 lbs?

- Yes
- No
- N/A

16. Flush Controls

Are the flush controls mounted no higher than 44 inches above the floor surface?

- Yes
- No
- N/A

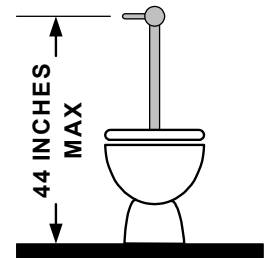

Are flush controls operable with one hand, not requiring tight grasping, pinching, or twisting of the wrist or more than 5 pounds of force?

- Yes
- No
- N/A

17. Clearance for Doors and Floor Space

Do all stall doors swing outward and provide a minimum of 32 inches of clearance?

- Yes
- No
- N/A

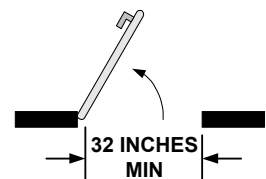

Is there a clear floor space in the interior of multi-fixture restrooms having a minimum diameter of 60 inches to allow for turning in a wheelchair or other mobility aid?

- Yes
- No
- N/A

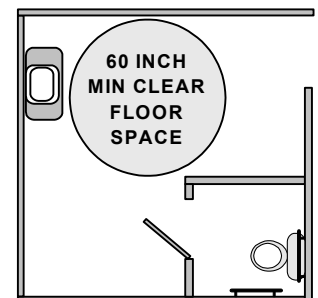

Where there is a privacy wall in a restroom, is there a minimum 60 inch diameter clear floor space for turning?

- Yes
- No
- N/A

SECTION V: PUBLIC TELEPHONES AND WATER FOUNTAINS

1. Public Telephones:

There a tactile mark on the Number 5 key
 The numbers are to be written in contrasting colours to the keys
 the area is to be well lit

Does it have a cord at least 29 inches long?

- Yes
- No
- N/A

- Yes
- No
- N/A

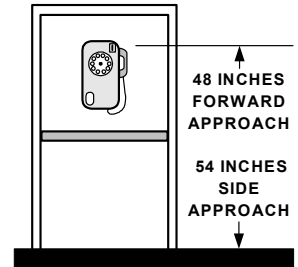

2. Access

Do telephone enclosures have a minimum clear path width for forward approach of 30 inches?

Is there a clear floor space of 30 x 48 inches provided at telephones?

- Yes
- No
- N/A

- Yes
- No
- N/A

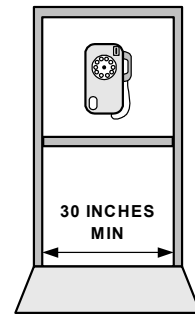

3. Directory Access

Are phone directories usable at wheelchair level? (see dimensions in the figure)

Are operation directions available in Braille and/or large print?

- Yes
- No
- N/A

- Yes
- No
- N/A

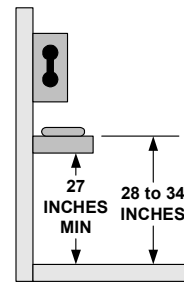

4. Auditory Amplification

Are telephones equipped with an amplifier?
 Note: 25% of total phones but never less than one must have amplification.

- Yes
- No
- N/A

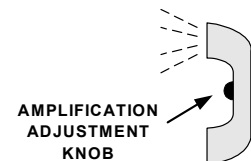

5. Text Telephone

If there are four or more public telephones, is at least one a public text telephone (TT)?

Note: Text Telephones are also known as Telecommunication Devices for the Deaf (TDD) or Tele-Type Writers (TTY).

Are text telephones identified by the symbol shown at the right?

- Yes
- No
- N/A

- Yes
- No
- N/A



SECTION V: PUBLIC TELEPHONES AND WATER FOUNTAINS

6. Access to Water Fountain

If free-standing or built-in water fountains do not have a clear, open space under them, is there clear floor space of 30 x 48 inches for parallel approach plus space for maneuvering?

Is the spout of the drinking fountain located in the front of the unit with a water flow trajectory that is parallel or nearly parallel to the front of the unit?

- Yes
- No
- N/A
- Yes
- No
- N/A

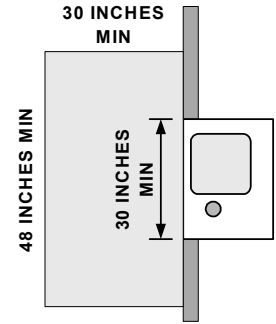

7. Height

Is there a water fountain available that is mounted to provide a minimum clearance of 27 inches and depth of 17 to 19 inches so that it can be approached and used by a person in a wheelchair?

Is the width of the water fountain at least 30 inches? (See figure in Item 6 above)

Is the maximum height of the water spout 36 inches?

- Yes
- No
- N/A
- Yes
- No
- N/A
- Yes
- No
- N/A

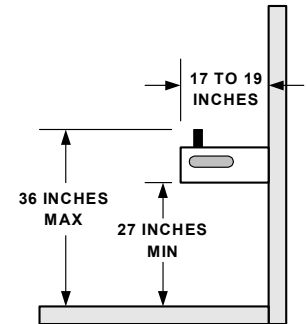

8. Hand Controls

Are the controls on the water fountain located on the front or on the side near the front, can the controls be operated with one hand, not requiring tight grasping, pinching, or twisting, and can the controls be operated with 5 pounds of force or less?

- Yes
- No
- N/A

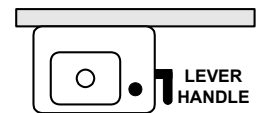

9. Existing Water Fountain

Are drinking cups provided when water fountain exceeds recommended height?

- Yes
- No
- N/A



SECTION VI: MEETING ROOMS

1. Accessible Rooms

Are accessible meeting rooms available?

- Yes
- No
- N/A

2. Location

Are the accessible meeting rooms centrally located in the facility to prevent unnecessary long travel for people with mobility impairments?

- Yes
- No
- N/A

3. Accessible Route

Do hallways and corridors have a clearance of 36 inches with an occasional space allowance for turning and passing at intervals not exceeding 200 feet?

- Yes
- No
- N/A

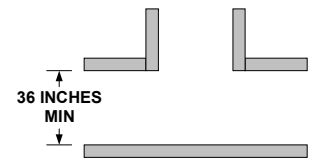

4. Door Width

Do the doors to meeting rooms have a minimum clear opening of 32 inches?

- Yes
- No
- N/A

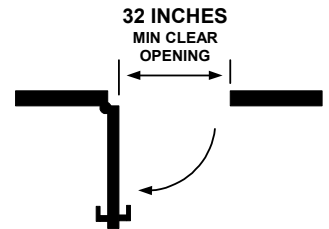

5. Thresholds

Do thresholds of interior doors have a maximum edge height of 1/2 inch? (See Section III, Part 10)

- Yes
- No
- N/A

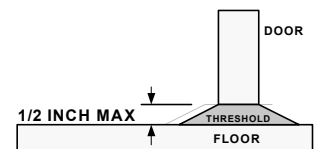

6. Amplifier and Sound System Equipment

Is there amplifier and sound system equipment available with individual or lavalier microphones?

- Yes
- No
- N/A

7. Floor

Is the meeting room floor non-slip, level, and negotiable by persons in wheelchairs and other mobility aids?

- Yes
- No
- N/A

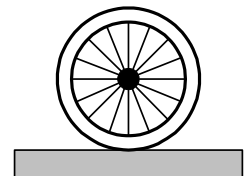

SECTION VI: MEETING ROOMS

8. Seating for People using Wheelchairs

Is there adequate space for seating at least two people using wheelchairs?

- Yes
- No
- N/A

Are the spaces for people using wheelchairs dispersed throughout the room within easy viewing of the stage?

- Yes
- No
- N/A

Are the spaces for people using wheelchairs or other mobility aids near accessible exits?

- Yes
- No
- N/A

9. Table Placement

If tables are used in the meeting rooms, is there a minimum clearance of 36 inches in the aisles?

- Yes
- No
- N/A

Are the spaces for wheelchair access at the tables at least 30 inches wide?

- Yes
- No
- N/A

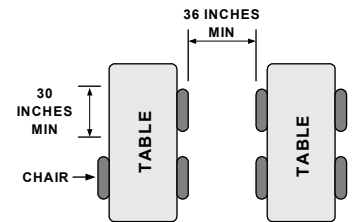

10. Table Height

Do tables have a clear opening for knee space of at least 27 inches in height, 30 inches in width, and 19 inches in depth?

- Yes
- No
- N/A

Is the top surface of the table 28 to 34 inches from floor surface?

- Yes
- No
- N/A

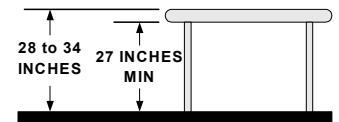

11. Listening System

If requested, are participants provided with interpreter services or a listening system and are they seated within 50 feet of the stage for viewing?

- Yes
- No
- N/A

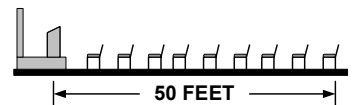

12. Temporary Ramp

Is a temporary ramp for the podium or head table available?
Note: Maximum slope of ramp is 1 inch vertical rise in every 12 inches of horizontal distance.

- Yes
- No
- N/A

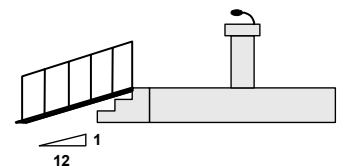

SECTION VI: MEETING ROOMS

13. Microphones

Are the microphones accessible and flexible?

- Yes
- No
- N/A



14. Lighting System

Is the lighting non-glare, non-reflecting, and non-blinking?

- Yes
 - No
 - N/A
-

SECTION VII: RESTAURANTS

1. Entrance

Do entrances to food service establishments have a door with a 32 inch clear opening, single effort door pull, and negotiable thresholds of 3/4 inch or less in height and beveled at a slope of 1:2?

- Yes
- No
- N/A

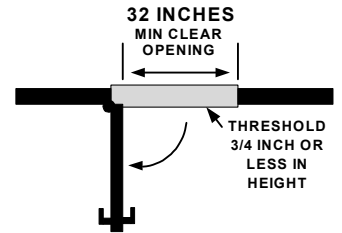

2. Tables

Are tables accessible? (A 30 inch width for individual seating, 27 inches minimum knee clearance, and minimum 19 inches depth under the table)

- Yes
- No
- N/A

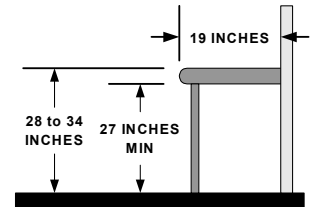

Are tables placed to provide a 36 inch wide aisle clearance?

- Yes
- No
- N/A

Is the top surface of the table 28 to 34 inches from floor surface?

- Yes
- No
- N/A

3. Cafeteria/Buffer Lines

Are cafeteria/buffet lines accessible—at least 36 inches clear opening with adequate turning space at corners?

- Yes
- No
- N/A

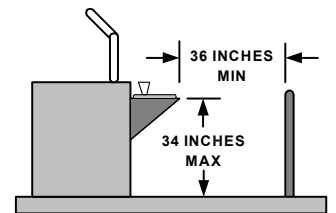

Are tray slides mounted at a maximum of 34 inches above the floor?

- Yes
- No
- N/A

4. Menus

Does the restaurant provide menus in Braille and large print?

- Yes
- No
- N/A

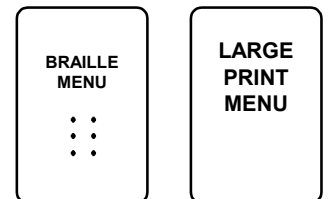

5. Special Needs

Is the restaurant staff able and willing to make reasonable accommodations for patrons such as making minor menu changes, reading menus, and assisting with trays?

- Yes
- No
- N/A



SECTION VII: RESTAURANTS

6. Lounge

Are the lounge entrance, tables and aisles accessible?

- Yes
- No
- N/A



7. Fixed Tables

Where fixed tables are provided, are at least 5 percent of the tables (with a minimum of one table) accessible?

Note: The required number of accessible fixed tables or counters shall be proportionally distributed between smoking and non-smoking areas.

- Yes
 - No
 - N/A
-

SECTION VIII: GUEST ROOMS

1. Room Keys

Is there a tactile method for identifying which way a key card should be inserted into an electronic lock?

- Yes
- No
- N/A

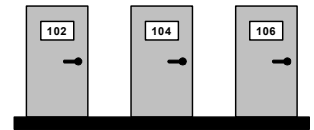

Additional:

Are entrances to fire escapes labelled in braille and/or with raised letters?

2. Keys

Are room keys available with a large fixed handle for easy handling?

- Yes
- No
- N/A

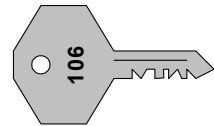

3. Door

Do entry, bathroom, and closet doors have a minimum clear opening of 32 inches with maximum threshold height of 1/2 inch with beveled edges of 1:2 slope as necessary? (See Section III, Part 10)

- Yes
- No
- N/A

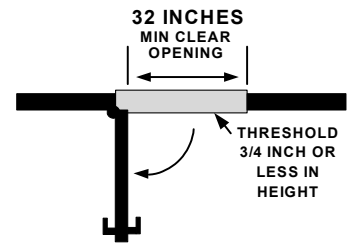

4. Bed Spacing

Is there a minimum clear opening of 36 inch by at least one side of the bed?

- Yes
- No
- N/A

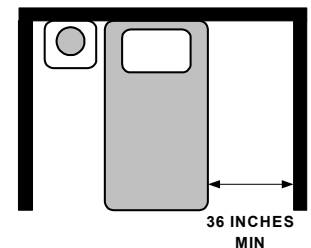

5. Telephones

Is there at least one telephone in the room which is accessible from the bed?

- Yes
- No
- N/A

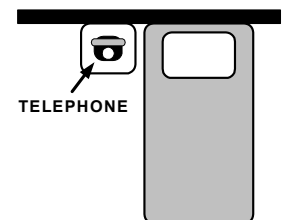

6. Amplified Telephones

Are amplified telephones and text telephones available for guests?

- Yes
- No
- N/A

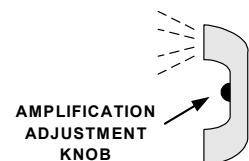

SECTION VIII: GUEST ROOMS

7. Protruding Objects

Are rooms free of wall-mounted objects, such as televisions, shelves and lamps, that protrude more than 4 inches?

- Yes
- No
- N/A

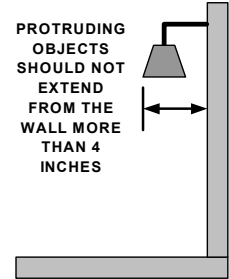

8. Switch Access

Are light switches, controls for heating and cooling, and draperies, and other similar items accessible and placed so that they will allow access by forward or parallel approach in a wheelchair or other mobility aid?

Are tactile instructions available on controls?

- Yes
- No
- N/A
- Yes
- No
- N/A

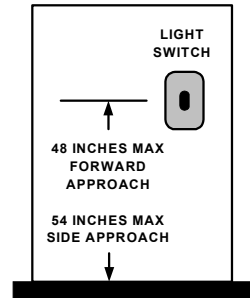

9. Closet and Towel Racks

Are towel and closet racks mounted at a maximum height of 48 inches?

- Yes
- No
- N/A

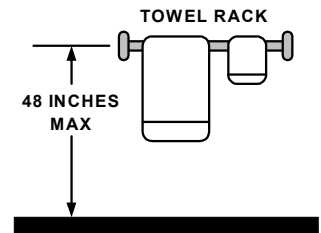

10. Space for Wheelchairs

Do guest rooms and bathrooms allow sufficient turning space for wheelchairs (60 inch diameter space is preferred)?

- Yes
- No
- N/A

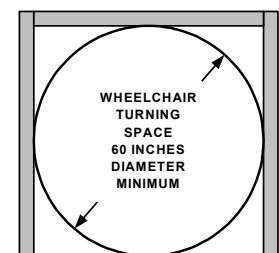

11. Mirrors

Is the mirror mounted at a maximum height of 40 inches measured from the floor to the bottom edge of the reflective surface?

- Yes
- No
- N/A

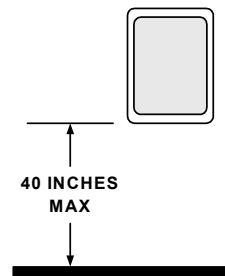

SECTION VIII: GUEST ROOMS

12. Lavatory Clearance

Is the lavatory mounted at least 29 inches from the floor to provide knee clearance, at a maximum height of 34 inches to the top surface of the lavatory, and with the bottom of the drain pipe at least 9 inches from the floor surface? (See Section IV - Restrooms)

- Yes
- No
- N/A

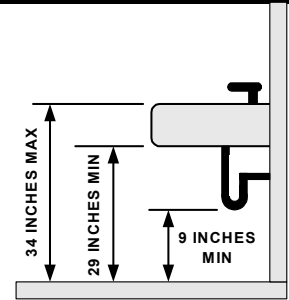

13. Exposed Hot Water and Drain Pipes

Is insulation or protective covering used on drain and hot water pipes under the lavatory to prevent contact?

- Yes
- No
- N/A

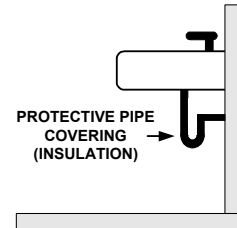

14. Water Closet Seat

Is the top of the water closet seat between 17 to 19 inches from the floor surface?

- Yes
- No
- N/A

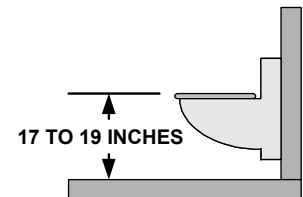

15. Grab Bars

Are grab bars of sufficient length and height (33 to 36 inches) mounted adjacent to the water closet and do these grab bars have a diameter of 1-1/4 to 1-1/2 inches, is there a 1-1/2 inch space between the grab bar and the wall, and are the grab bars able to support 250 pounds?

- Yes
- No
- N/A

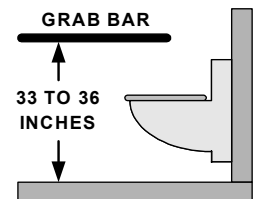

16. Faucet Controls

Are faucets controlled by a hand lever, push button, or electronic control that is easily operated by one hand, not requiring tight grasping, pinching, or twisting and operable with 5 pounds of force or less?

- Yes
- No
- N/A

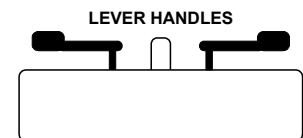

17. Shower and Tub Combinations

Do shower and tub combinations have curtains rather than glass doors?

- Yes
- No
- N/A

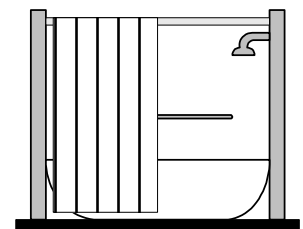

SECTION VIII: GUEST ROOMS

18. Grab Bars

Are grab bars of sufficient length, height and load capacity mounted in tub or shower?

- Yes
- No
- N/A

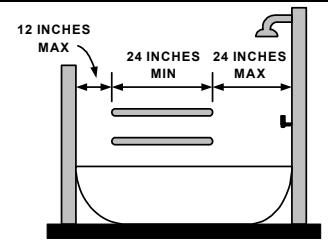

Do these grab bars have a diameter of 1-1/4 to 1-1/2 inches, is there a 1-1/2 inch space between the grab bar and the wall, and are the grab bars able to support 250 pounds?

- Yes
- No
- N/A

19. Bath Tub Bench

Is there a bench available for use in the tub?

- Yes
- No
- N/A

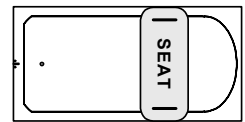

20. Shower Stall and Flexible Shower Hose

Is the floor space in the shower stall at least 36 x 36 inches?
 Note: Shower stalls that would fit into the space required for a bathtub (30 by 60 inches) are also allowed.

- Yes
- No
- N/A

Does the shower spray unit have a flexible hose of at least 60 inches long and can the shower head be used as both a hand-held and fixed unit?

- Yes
- No
- N/A

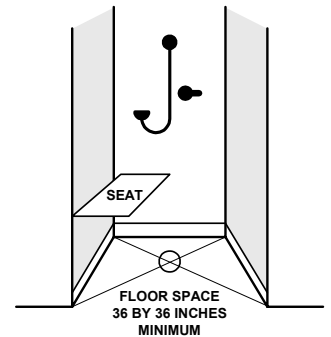

Is a seat provided in the shower stall?

- Yes
- No
- N/A

SECTION VIII: GUEST ROOMS

21. Number of Accessible Rooms

Does the number of accessible guest rooms or suites available comply with the table below?

Number of Rooms	Accessible Rooms	Rooms with Roll-in Shower
1 to 25	1	—
26 to 50	2	—
51 to 75	3	1
76 to 100	4	1
101 to 150	5	2
151 to 200	6	2
201 to 300	7	3
301 to 400	8	4
401 to 500	9	4 plus one for each additional 100 over 400
501 to 1000	2% of total	
1001 and over	20 plus 1 for each 100 over 1000	

- Yes
 No
 N/A

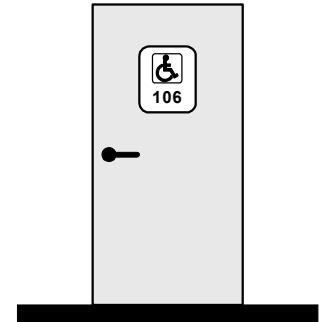

22. Sleeping Accommodations for Persons with Hearing Impairments

In addition to the number of accessible rooms or suites required above, do the number of rooms with Visual Alarm Notification Devices and Text Telephones comply with the following table?

Number of Rooms/Suites	Rooms with Visual Alarms and Text Telephones
1 to 25	1
26 to 50	2
51 to 75	3
76 to 100	4
101 to 150	5
151 to 200	6
201 to 300	7
301 to 400	8
401 to 500	9
501 to 1000	2% of total
1001 and over	20 plus 1 for each 100 over 1000

- Yes
 No
 N/A

SECTION IX: HAZARDS AND EMERGENCY PROCEDURES

1. Staff Awareness

Has the staff received special instructions about the needs of persons with disabilities, particularly emergency procedures?

- Yes
- No
- N/A

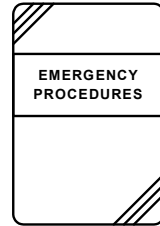

2. Hazardous Vehicular Area

Is the boundary between the pedestrian and vehicle area marked with some type of tactile warning if not separated by curbs, rails or similar element?

Note: Truncated domes having a diameter of 0.9 inches, a height of 0.2 inches, a center-to-center spacing of 2.35 inches, and of a color that contrasts with the walk surface may be used as a tactile warning.

- Yes
- No
- N/A

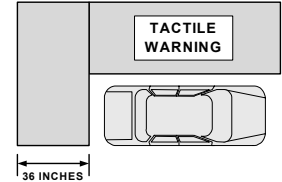

3. Standard Warnings at Subsurface Pools

Are standardized textured surfaces for tactile warnings (i.e. rails, walls, curbs, or truncated domes) present at subsurface pools?

- Yes
- No
- N/A

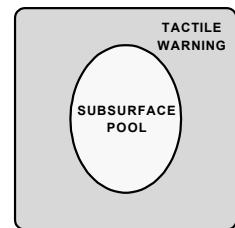

4. Emergency Exits

Are all emergency exit doors clearly marked, and do they have a minimum opening of 32 inches?

Are exit doors equipped with tactile symbols to designate their location?

- Yes
 - No
 - N/A
-
- Yes
 - No
 - N/A

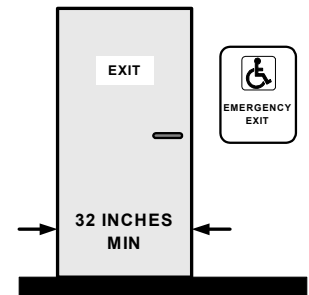

SECTION IX: HAZARDS AND EMERGENCY PROCEDURES

5. Audible and Visual Alarm Signals

Are all audible alarms accompanied by visual alarms?

- Yes
- No
- N/A

Do audible alarms produce a noise which exceeds the ambient noise level by at least 15 decibels?

- Yes
- No
- N/A

Are visual alarms xenon strobe type (or equivalent) with intensity of 75 candela and a flash rate of 1 per second minimum and 3 per second maximum?

- Yes
- No
- N/A

Are visual alarms not more than 50 feet apart and mounted 80 inches above highest floor level or 6 inches below the ceiling, whichever is lower?

- Yes
- No
- N/A

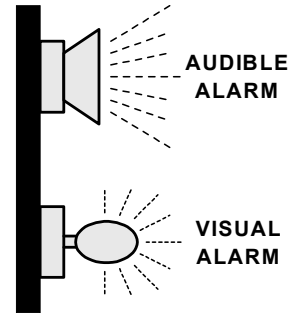

6. Area of Rescue

Except in fully sprinkled buildings, is there an area of rescue assistance that meets one of the following seven requirements specified in ADA Accessibility Guidelines and is it identified by a sign?

- Yes
- No
- N/A

1. Portion of a stairway landing within a smoke-proof enclosure.
 2. Portion of an exterior exit balcony located adjacent to an exit stairway.
 3. Portion of a one-hour fire restrictive corridor located adjacent to an exit enclosure.
 4. Fire-resistive vestibule located adjacent to an exit enclosure.
 5. Portion of a stairway landing within an exit enclosure which is vented and separated from the interior of the building with fire-resistive doors (not less than one hour).
 6. An area or room separated from portions of the building by a smoke barrier.
 7. An elevator lobby with shafts that are pressurized once activated by smoke detectors.
-

SECTION X: ELEVATORS AND AUTOMATED TELLER MACHINES (ATM)

1. Elevators

- Does the facility have a passenger elevator? Yes
 No
 N/A
- Does the elevator provide access to all levels of the facility? Yes
 No
 N/A

2. Signal Identification

Are there both visual and audible signals used to identify direction of elevator travel (for example, for audible alarms, one sound for UP and two sounds for DOWN)?

- Yes
 No
 N/A

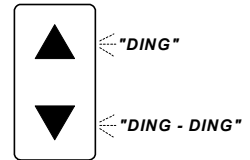

3. Accessible Routes

Are the accessible elevators on a normally used accessible route?

- Yes
 No
 N/A

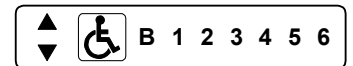

4. Call Buttons/Floor Buttons

Are call buttons in lobbies and halls mounted at 42 inches (on center) above the floor with no access obstructions?

- Yes
 No
 N/A

Are there raised and Braille floor destinations on both sides of elevator jamps 60 inches above the floor surface?

- Yes
 No
 N/A

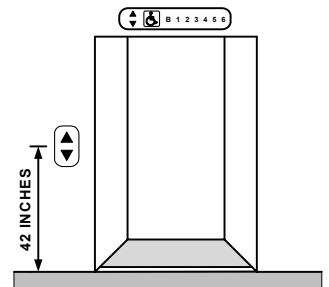

5. Elevator Car Dimensions

Does the elevator have minimum inside dimensions of 54 x 80 inches and a minimum clear door opening of 36 inches?

Note: If the elevator door is not on center of the elevator entrance, the interior dimensions should be 54 x 68 inches.

- Yes
 No
 N/A

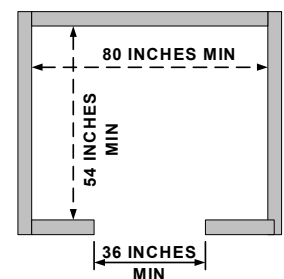

SECTION X: ELEVATORS AND AUTOMATED TELLER MACHINES (ATM)

6. Leveling

Does the elevator stop within 1/2 inch above or below the outside floor surface on each level?

- Yes
- No
- N/A

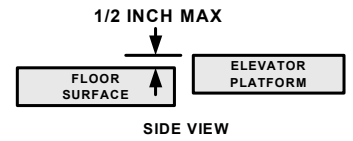

7. Space Between Elevator and Floor

Is the open space between the outside floor surface and the elevator platform no greater than 1-1/4 inches?

- Yes
- No
- N/A

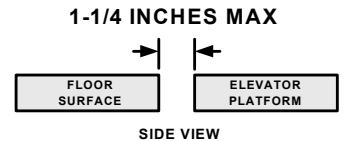

8. Floor Protective Re-Opening Device

Are the elevators equipped with a safety system that automatically opens the door when it becomes obstructed by an object or person?

- Yes
- No
- N/A

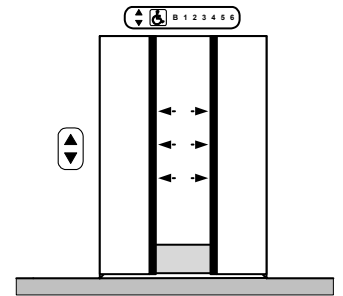

9. Handrails

Does the elevator interior have handrails mounted 34 to 36 inches above the floor and with a clear space of 1-1/2 inches between the rail and the wall?

- Yes
- No
- N/A

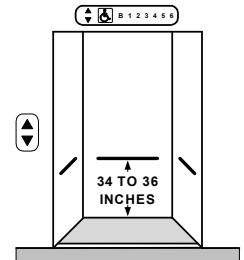

10. Controls, Call Buttons and Alarms

Are controls, call buttons, and alarm buttons at least 3/4 inch in diameter with Braille and raised lettering located to the left of each control or button?

- Yes
- No
- N/A

Are all controls or buttons on the elevator control panel mounted no higher than 48 inches above the floor?

- Yes
- No
- N/A

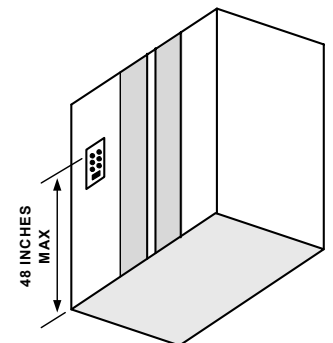

SECTION X: ELEVATORS AND AUTOMATED TELLER MACHINES (ATM)

11. Automated Teller Machines (ATM)

Is there sufficient clear floor space (30 x 48 inches) adjacent to the ATM to allow for forward or parallel approach by a wheelchair?

- Yes**
- No**
- N/A**

Is the maximum height of all operable controls or buttons 48 inches for a front approach or 54 inches for a parallel approach by a wheelchair?

- Yes**
- No**
- N/A**

Are instructions and information for use of the ATM accessible to persons with visual impairments?

- Yes**
 - No**
 - N/A**
-

SECTION XI. ACCESSIBILITY FOR THE WORLD WIDE WEB

Content published on the World Wide Web should be designed to meet the **Web Content Accessibility Guidelines** published by the Web Accessibility Initiative (WAI) of the World Wide Web Consortium (W3C). Web content that complies with these guidelines will also be more available to all users.

The “**Quick Tips**” below are a brief summary of these guidelines for Web site designers and others responsible for ensuring accessibility of Web content. The **Web Content Accessibility Guidelines** and other related information are available on the Web at: www.w3.org/WAI/.

Quick Tips to Make Accessible Web Sites:

- **Images and Animations:** Use the **alt** attribute to describe the function of each visual element.
- **Image Maps:** Use client-side **MAP** and text for hotspots.
- **Multimedia:** Provide captioning and transcripts of audio, and description of video.
- **Hypertext Links:** Use text that makes sense when read out of context. For example, avoid “Click Here”.
- **Page Organization:** Use headings, lists, and consistent structure. Use Cascading Style Sheets for layout and style where possible.
- **Graphs and Charts:** Summarize or use **longdesc** attribute.
- **Scripts, Applets and Plug-ins:** Provide alternative content in case active features are inaccessible or unsupported.
- **Frames:** Use **NOFRAMES** and meaningful titles.
- **Tables:** Make line-by-line reading sensible. Summarize.
- **Check Your Work:** Validate your Web pages. Use tools, checklists, and guidelines. For example, the “Bobby” validation tool is available at: www.cast.org/bobby/

Copyright 1999, World Wide Web Consortium, MIT



Jamaica Council for Persons with Disabilities

EDUCATING • ADVOCATING • EMPOWERING

The Jamaica Council for Persons with Disabilities
ACCESSIBILITY CHECKLIST